

پروفیل های کرتین وال

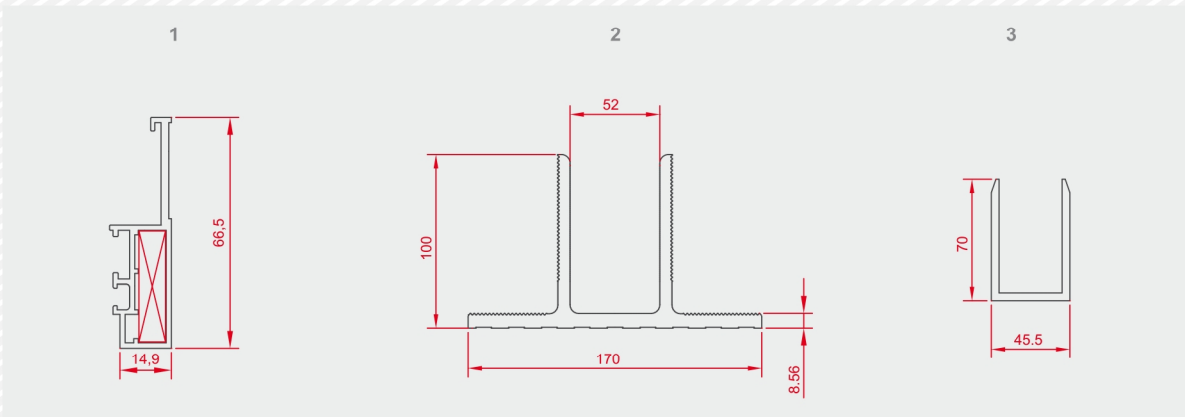

10420

پروفیل اتصال به دیوار  
conection to wall beraket  
0.725 Kg/m

10430

براکت اتصال به دیوار  
conection to wall beraket  
7.526 Kg/m

10435

براکت اتصال به کف  
conection to wall beraket  
4.157 kg/m

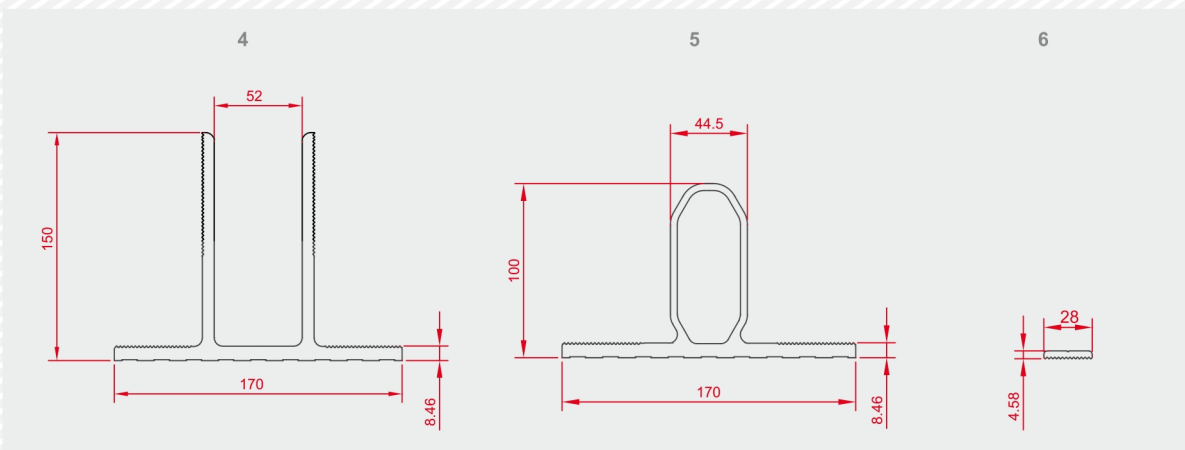

10431

براکت اتصال به دیوار  
conection to wall beraket  
9.540 kg/m

10433

براکت اتصال به سقف  
conection to wall beraket  
6.31 kg/m

10434

مهره براکت  
conection to wall beraket  
0.323 kg/m

Caped Curtain Wall System Fixers List





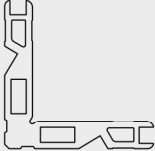
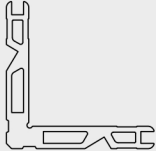





Profil Number (6metr)	20021	10338	20771	20770
Drawing				
Fixer Name	AP20187 INNER	AP10241 AP10242 AP21035	AP20187 OUTER AP20774 AP5068	AP20773 AP10420 AP5056
Cutting Lenght(Mm)	32	41.3 31.8 31.8	16.6 6 16.6	25.6 25.6 7.9
Weght(Kg/m)	3.087	2.505	3.60	3.60

### Structural Glazing System Fixers List

Profil Number (6metr)	20021	10338
Drawing		
Fixer Name	AP20882 INNER AP20883 INNER AP20883 OUTER AP20885 AP20886 INNER AP20886 OUTER	AP20882 OUTER AP10422 OUTER
Cutting Lenght(Mm)	31.9 26.1 10.2 10.2 10.2 6.1	30.1 27
Weght(Kg/m)	3.087	2.505

آلومینیومی پانچی=AP

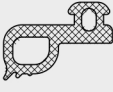

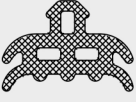
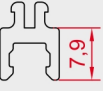
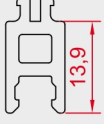
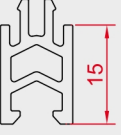
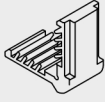
	EPDM 	EPDM 	EPDM 	EPDM 
Part no.	CF03	CF04	CF05	CF05 A
	EPDM 	EPDM 	EPDM 	EPDM 
Part no.	CF07	CF09	MF08	YF03
	EPDM 	EPDM 	EPDM 	EPDM 
Part no.	TF20	KYF10	KTF20	CYF10
	EPDM 	PVC 	PVC 	PVC 
Part no.	CTEC30	NPP028	NPP121	NPP351
				
Part no.	KP20887			