

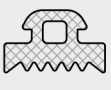

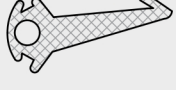

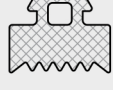

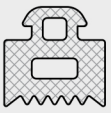
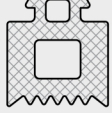
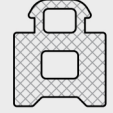

50R TUTI Hidden Vent Profiles

Form	EPDM 	EPDM 	EPDM 	EPDM 
Code	CF 03	51027	CF 05	CF 05A
Form	EPDM 	EPDM 	EPDM 	EPDM 
Code	CF 07	CF 09	MF 08	YF 03
Form	EPDM 	EPDM 	EPDM 	EPDM 
Code	TF 20	EP MO61	50R5003 قطعه‌ی آب‌و کورتین وال	MOL
Form	EPDM 	PVC 		EPDM 
Code	CTF 30	NPP 028 7.9	KP 20887	50R10450
Form	EPDM 	EPDM 		
Code	50R10454	50R10455	بیراق دوجالته لنگه مخفی	

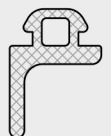
کدهای لولای کاردی کرتینوال

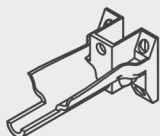
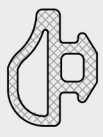
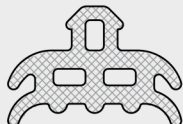
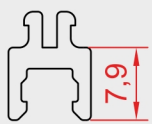
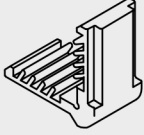
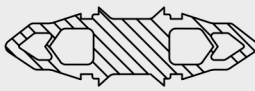
GIESSE		GS HD "P"		نوع لولای کاردی باز شو Friction Hinge		اندازه لنگه ی باز شو		
لولای کاردی باز شو Friction hinge	Code	عرض لولای کاردی (mm)	خاصی کار (mm)	طول لولای کاردی (mm)	ماکسیمم درجه ی باز شو	ماکسیمم ارتفاع باز شو (mm)	ماکسیمم عرض باز شو (mm)	ماکسیمم وزن باز شو Kg
S HD-10" P Tipi	08534000N	23	16+0.5	261.5	35°	700.00	1200	50
S HD-12" P Tipi	08535000N	23	16+0.5	317.5	30° / 35°	800.00	1200	60
S HD-14" P Tip	08536000N	23	16+0.5	353.5	30° / 35°	1000.00	1300	69.5
S HD-16" P Tipi	08537000N	23	16+0.5	414.5	25° / 30°	1200.00	1400	88.5
S HD-18" P Tipi	08538000N	23	16+0.5	458.5	25° / 30°	1400.00	1400	102
S HD-20" P Tipi	08539000N	23	16+0.5	511.5	20° / 25°	1600.00	1500	135
S HD-22" P Tipi	08534000N	23	16+0.5	556.5	20° / 25°	1700.00	1500	137
S HD-24" P Tipi	08534100N	23	16+0.5	602.5	20° / 25°	1800.00	1500	139
S HD-28" P Tipi	08534200N	23	16+0.5	707.5	10° / 15° / 20°	2000.00	1500	155

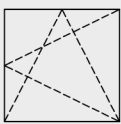
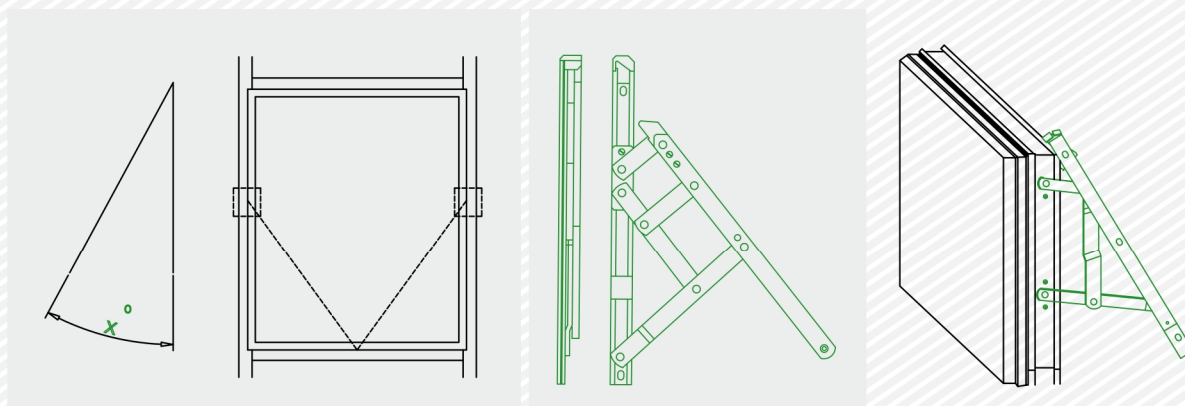

50R Tuti Hidden Vent System Fixers List

Profil Number (6metr)	20445	20771
Drawing		
Fixer Name	AP10456 INNER AP10807 INNER	AP10456 OUTER AP10807 OUTER
Cutting Lenght(Mm)	52 52	13.6 21.4
Weght(Kg/m)	2.676	3.60

AP= آلومینیومی پانچی